



Lift Pins and Step Pins for Wetcast Forms



Intelligent Formwork Accessories

- Lift Pins
- Lift Inserts
- Blockout Hole Former Pins
- Step Pins
- Breakoff Step Inserts



Lift Pins, Lift Inserts, Blockout Hold Former Pins

LIFT PIN ASSEMBLIES

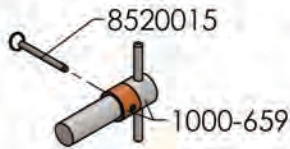

**LANE EZ-LIFT
LIFT PIN**



**LANE EZ-LIFT
BLOCK OUT**

PIN REPLACEMENTS



**3/8" SPRING PIN
WITH HANDLE**

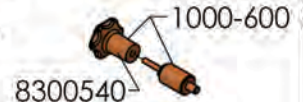

**3/8" SPRING PIN
WITH KNOB**



**LANE SCREW IN TYPE
BLOCK OUT**

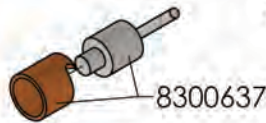

**LANE SCREW IN TYPE
LIFT PIN**

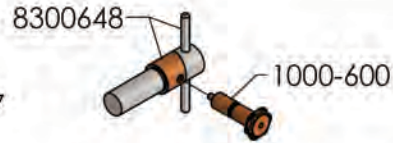

**M.A. INDUSTRIES
CAM PIN**



**M.A. INDUSTRIES
BREAKOFF LIFT
INSERT SLEEVE**

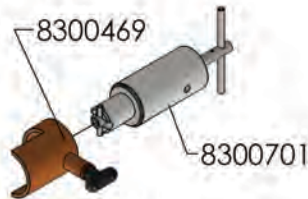

**PRESS SEAL
3" LIFT PIN**

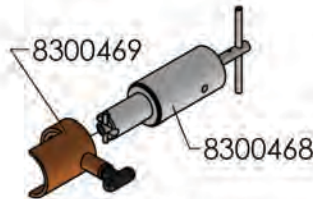

**PRESS SEAL
4" LIFT PIN**

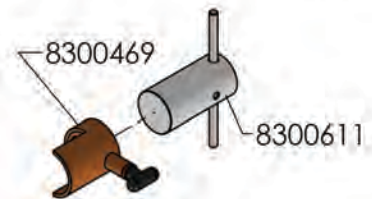

**PRESS SEAL
BLOCK OUT**

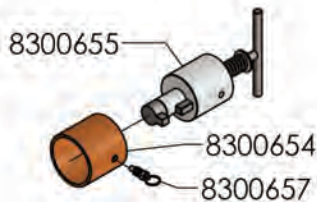

**A-LOK
LIFT PIN**

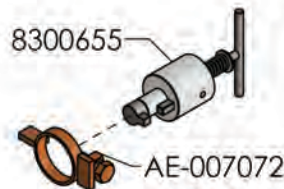

**A-LOK
LIFT PIN**



**A-LOK
KEY LOCK WASHER**

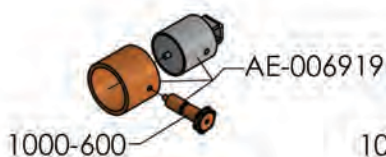

2 TON SWIFT LIFT

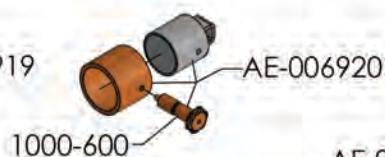

**2 TON SWIFT LIFT
BLOCK OUT**

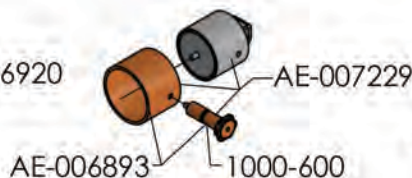

4 TON SWIFT LIFT

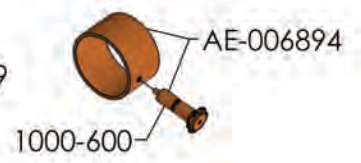

**8 TON SWIFT LIFT
SLEEVE**



A Lok



A Lok (Key Hole)



Press Seal



M.A. Industries & Lane International



Step Pins, Breakoff Step Inserts

STEP PIN ASSEMBLIES

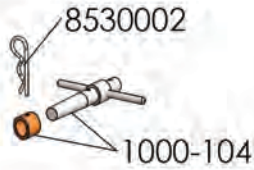

**MANUAL REVERSIBLE
STEP PIN
PS1-PF OR PS2-PF**

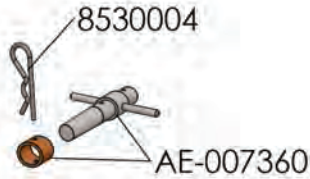

**MANUAL REVERSIBLE
STEP PIN
PS2-PFSL-DF
AMERICAN LML-13**



**BREAK AWAY
STEP PIN SLEEVE
PS1-PF OR PS2-PF**



**BREAK AWAY
STEP PIN SLEEVE
PS2-PFSL-DF
AMERICAN LML-13**

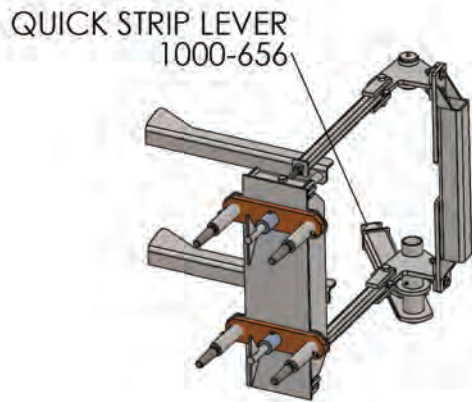

**QUICK STRIP
STEP PIN ASSEMBLY
PS1-PF OR PS2-PF**



**HYDRAULIC
STEP PIN ASSEMBLY
PS1-PF OR PS2-PF**

STEP PINS CAN BE SPACED FOR ALL TYPICAL HORIZONTAL AND VERTICAL SPACINGS.



Reversible Blockout Step Pin/Hole Former

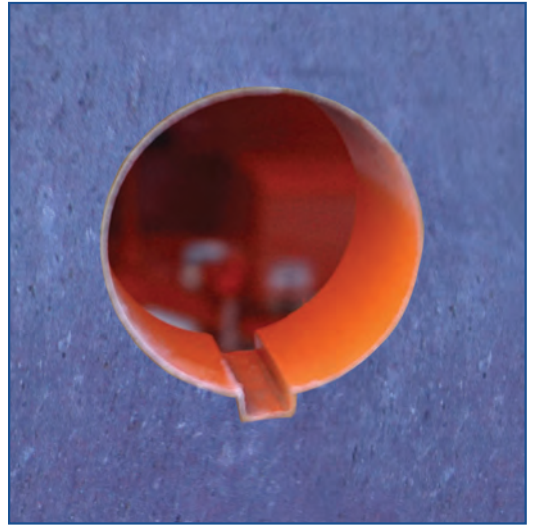

Plastic Breakoff Step Insert Former



Blockout Step Pin/Hole Former



Manhole Stack Up

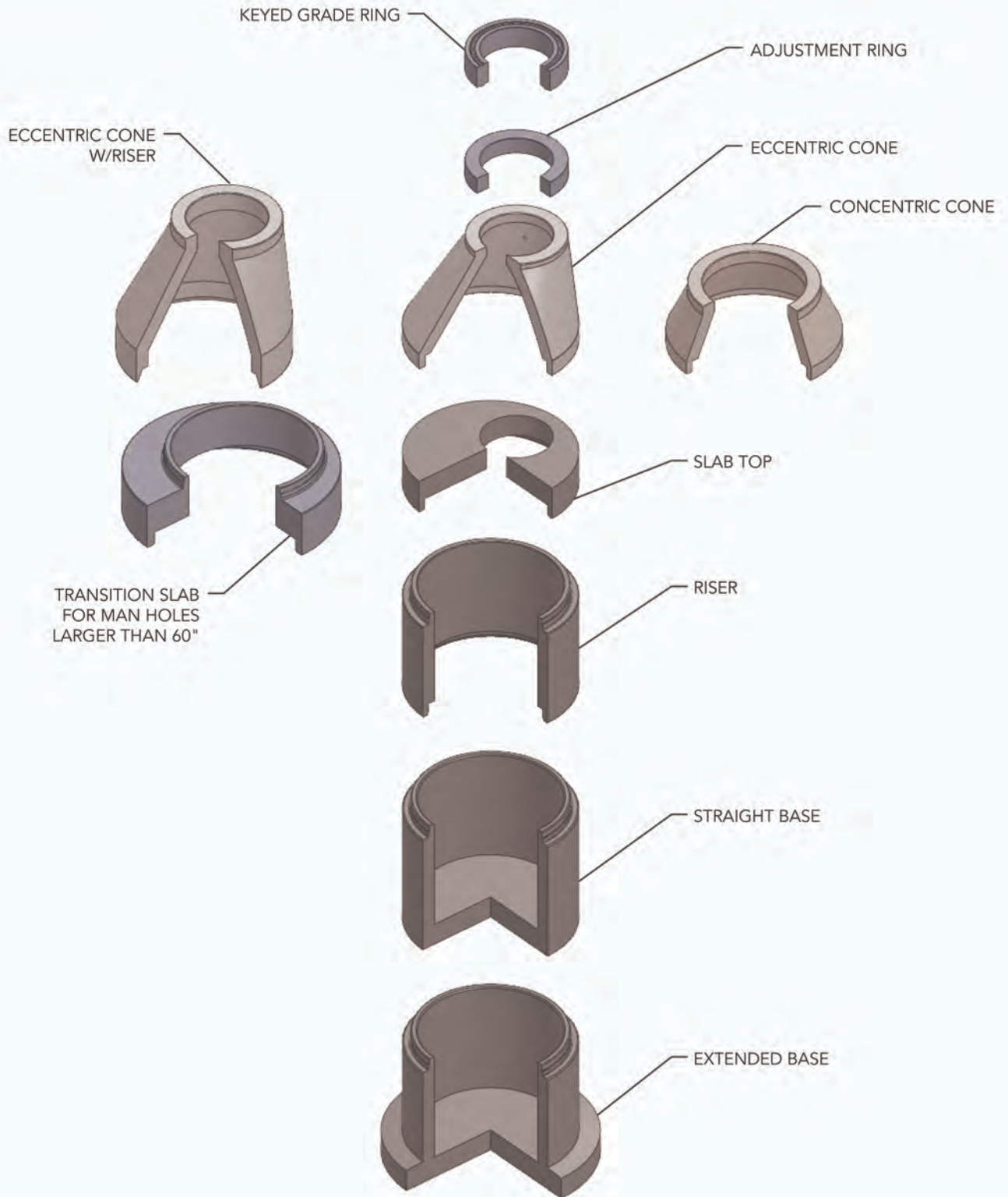



Forming Systems

For Every Application

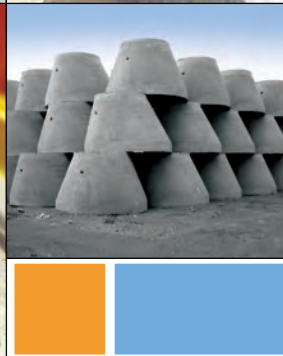

Manhole Forming Systems

Monolithic Straight and Extended Bases, Risers, Cones, Slab Tops and more



Box Forming Systems

Monolithic Straight and Extended Bases, Risers, Cones, Slab Tops and more



Transportation Forming Systems

- Arch/Bridge
- Median Barriers
- For industrial or commercial applications
- Curbing
- Retaining and Sound Walls
- Headwalls

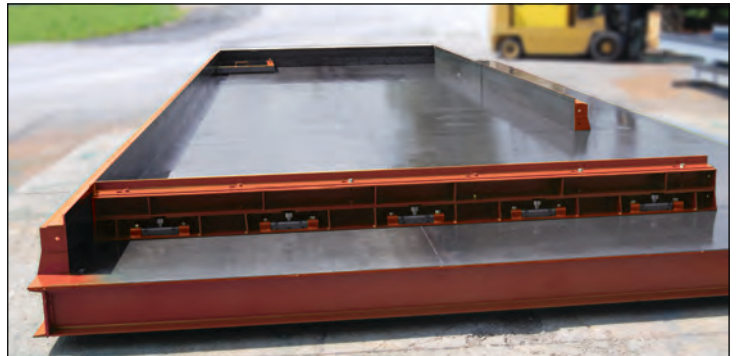

Flatcasting Tables and Side Rails

Simplify wall panel, foundation, slab panel production

Contact the Afinitas Forming Systems Sales Team

to learn more.

Phone (641) 394-4111

or email rfq@afinitas.com



Lift Pins and Step Pins for Wetcast Forms

Equipment & Automation



Forming Systems

Concrete Accessories



Intelligent Infrastructure Solutions
Visit www.afinitas.com to learn more.

Afinitas Forming Systems Division

Iowa

928 W Milwaukee
New Hampton, IA 50659
Phone: 641-394-4111
Fax: 641-394-4542
rfq@afinitas.com

Ohio

1701 Moler Road
Columbus, OH 43207
Phone: 614-444-2184
rfq@afinitas.com



Intelligent Infrastructure Solutions

Afinitas is a global, comprehensive and customer-oriented equipment, automation, forming and accessories platform for precast concrete and infrastructural products.

Afinitas Forming Systems Division:
928 W. Milwaukee | New Hampton, IA 50659 USA | +1 641-394-4111 | rfq@afinitas.com | www.afinitas.com